













Dati Tecnici - Specifications

											
	cond	comp. W	ABS. W	Fuse	Kwh/100Kg	l / h	kg	Lbs	kg	Lbs	Ton CO2 equiv.
CS20 A		559	440	10	42.4	2.46	28	62	33	73	0.286
CS20 W		559	360	10	38.0	28.1	28	62	33	73	0.260

24h Produzione Ghiaccio - Ice Production

Raffreddamento ad aria - Air Cooled Unit

Temp. aria Air Temp.	Temp. acqua / Water Temp.			
	32°	21°	15°	10°
°C	32°	21°	15°	10°
°F	90°	70°	60°	50°
10°	18	19	20	21
50°	40	42	44	46
21°	16.5	17.5	18.5	19.5
70°	36	39	41	43
32°	14	15	16	17
90°	31	33	35	37
38°	11	12	13	14
100°	24	26	29	31

Raffreddamento ad acqua - Water Cooled Unit

Temp. aria Air Temp.	Temp. acqua / Water Temp.			
	32°	21°	15°	10°
°C	32°	21°	15°	10°
°F	90°	70°	60°	50°
10°	18	19	20	21
50°	40	42	44	46
21°	16	17	18	19
70°	35	37	40	42
32°	15.5	16.5	17.5	18.5
90°	34	36	39	41
38°	13	14	15	16
100°	29	31	33	35

Vista frontale
Front view

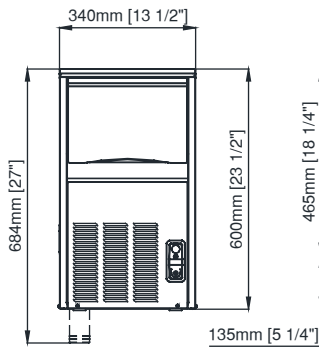

Vista laterale
Lateral view

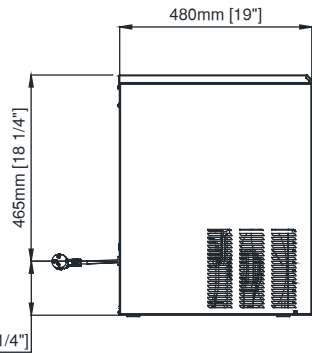

Interruttore ON-OFF
Switch ON-OFF

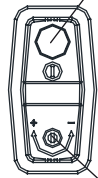

Size ice regulation screw
Vite regolazione
dimensione ghiaccio



Kit 4 Feet Optional
Kit 4 piedini Optional
Ø50mm H100-120 mm

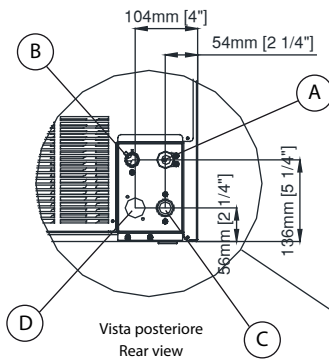
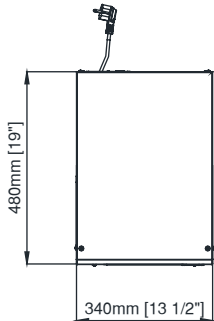

A Electrical cable supply / Ingresso alimentazione elettrica

B Water outlet connection / Attacco scarico acqua diam. 20 mm

C Water inlet connection / Attacco entrata acqua - 3/4" gas

D Water outlet connection water condensation / Uscita acqua condensatore ad acqua diam. 20 mm



PANNELLO DI CONTROLLO - CONTROL PANEL



Interruttore On/OFF
Switch ON/OFF

Vite regolazione
dimensione ghiaccio
Size ice regulation screw

CAPACITA' DEPOSITO - BIN CAPACITY

6,5 Kg - 14,3 lbs / 325 pcs

DIMENSIONI - DIMENSIONS

LxPxH(mm): 340 x 480 x 605

WxDxH(in): 13" 6/16 x 19" 14/16 x 24" 13/16

DATI SPEDIZIONE / SHIPPING DATA

LxPxH(mm): 400 x 530 x 760

WxDxH(in): 16" 12/16 x 21" 14/16 x 30" 15/16

TIPO GHIACCIO - ICE TYPE

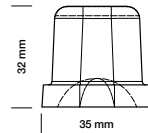

20g

PESO GHIACCIO
WEIGHT ICE

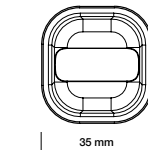

18

PZ / CICLO
PCS / CYCLE

CONDIZIONI USO-OPERATING REQUIREMENTS



220-240V / 50Hz / 1



R134a GWP=1430

MIN

MAX

10°C (50°F)



40°C (104°F)

5°C (41°F)



35°C (95°F)

- 10 %



+ 10 %

1 BAR (14 PSI)



5 BAR (70 PSI)

Calore espulso - Rejected Heat
Volume aria - Air Volume

977 W
185 m³/h